

# B&Q

## Assembly & Use Instructions **Albany 3 Burner Gas BBQ**





















---

These instructions are for your safety. Please read through them thoroughly before use and retain them for future reference.



## Parts Supplied

- Please note quantities of parts may vary according to model purchased.
- Please note the letter (P) in the description column denotes a preassembled part.

Ref	Description	Illustration	Qty	Ref	Description	Illustration	Qty
1	Hood - P		1	12	Left Leg		2
2	Hood Warming Rack		1	13	Right Leg		2
3	Cooking Grill		2	14	Side Shelf Support		4
4	Cooking Griddle		1	15	Trolley Base		1
5	Vapour Bar		2	16	Electronic Ignition		1
6	Spring Clip - P		3	17	Shield		1
7	Burner - P		3	18	Electronic Ignition Battery		1
8	Barbecue Body - P		1	19	Axle		1
9	Drip Tray		1	20	Wheel		2
10	Hose/Regulator Assembly		1	21	Locking Caster		2
11	Side Shelf		2				









## Tools Required (not supplied)

- Cross Head Screwdriver
- Adjustable Spanner

## Tools Required (supplied)

- Hex Spanner for Hose Assembly
- Hex Key

## Fixings Supplied

Ref	Description	Illustration	Qty	Ref	Description	Illustration	Qty
22	Locknut		2	26	Wing Nut, M6		8
23	Support Bolt, M6x75		8	27	Body Support Bolt, M6x65		8
24	Shelf Support Bolt, ST6.3x60		8	28	Locknut		8
25	Spacer		8	29	ST4.0x15 Screw		2

## Tools Required (not supplied)

- Cross Head Screwdriver
- Adjustable Spanner

## Tools Required (supplied)

- Hex Spanner for Hose Assembly
- Hex Key

## Before You Start

- Check the box and make sure you have all the parts and fittings listed. If not, contact your local B&Q store or the Helpline 0870 2427164 who will be able to help you.
- When you are ready to start, make sure that you have the right tools at hand, plenty of space and a clean dry area for assembly.

## Assembly

- Please lay out all nuts and bolts and check lengths before assembling. It is recommended that the carton is cut open and spread out on the floor and used as a protective surface during assembly. Refer to the assembly diagrams as necessary.
- Important - Whilst every care is taken in the manufacture of this product, care must be taken during assembly in case sharp edges are present.
- Remove all transit packaged parts from the inside of the grill body before assembling.



- **IMPORTANT - FOLLOW GAS LEAK TEST ADVICE BEFORE USE. ENSURE ALL CONNECTIONS ARE TIGHT AND SECURE.**
- This product is for **OUTDOOR USE ONLY**.
- **NEVER** use indoors, in an enclosed area or below ground level.
- This barbecue is intended for use with LPG bottled gas only. (A regulator of 28mbar must be used for Butane gas or 37mbar for Propane gas.)
- This appliance has been supplied with a **PROPANE REGULATOR** (only use with Propane gas).
- **NEVER** use an adjustable regulator with this barbecue.

## Trolley Assembly



[12] Left Leg, x2



[13] Right Leg, x2



[15] Trolley Base, x1



[28] Locknut, x4



[23] Support Bolt, M6x75, x4

### 1

Attach the Left Legs(12) to the Trolley Base(15) using the Support Bolts(23) and Locknut (28) as shown. (Hex key is needed, which is packed in hardware packs).

Note: There are extra two holes in the left front leg for electronic ignition.

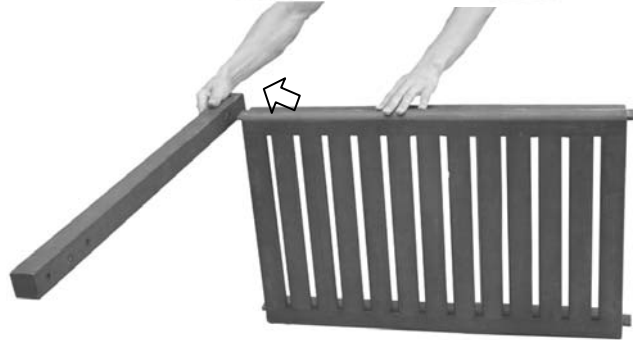
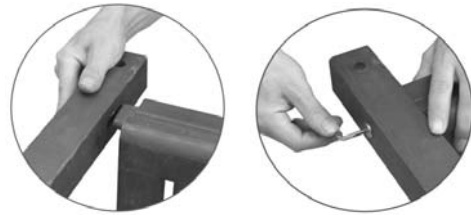

### 2

Attach the Right Legs(13) to the Trolley Base(15) using the Support Bolts(23) and Locknut (28) as shown. (Insert Locknut into the wood first, screw the Support with the help of hex key).

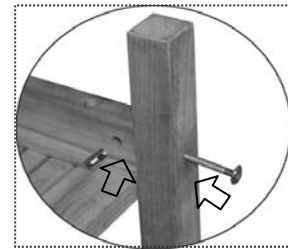

## Trolley Assembly



[20] Wheel, x2



[21] Locking Caster, x2



[19] Axle, x1



[22] Locknut, x2



[11] Side Shelf, x2

### 3

Screw the Locking Casters(21) into the end of the right legs and hand tighten until it stops. Thread the Axle(19) through left side legs, fit the Wheels(20) onto the axle at each end, and secure with Locknuts(22).

**Note: The wheels should be placed outside of the left legs.**



### 4

Attach the Side Shelves (11) to the trolley.  
(Details in next step)



## Trolley Assembly



[26] Wing Nut, M6, x8



[25] Spacer, x8



[27] Body Support Bolts, x8



[23] Support Bolt, M6x75, x4



[28] Locknut, x4

### 5

Secure the side shelves with the Support Bolt(23) and Locknut(28) as shown.  
(Insert Locknuts into the wood first, screw them with the help of hex key)

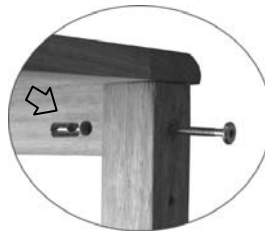

### 6

Insert Body Support Bolts(27) through legs, Spacers(25) and through the side walls of the body (Two more people are required to hold the body). Secure with Wing Nut(26). Make sure all 8 bolts are in place correctly.



## Trolley Assembly



[3] Cooking Grill, x2



[4] Cooking Griddle, x1



[5] Vapour Bars, x2



[2] Hood Warming Rack, x1



[14] Side Shelf Support, x4



[24] Shelf Support Bolts, x8

### 7

Lay Vapour Bars(5), Cooking Grill (3) and Cooking Griddle(4) and Warming Rack(2) as shown.

Note: Place the vapour bars onto the their brackets.

Note: The cooking grills must be located over the vapour bars.



### 8

Insert the Side Shelf Support(14) into the hold on the legs. And secure with Shelf Support Bolts(24).

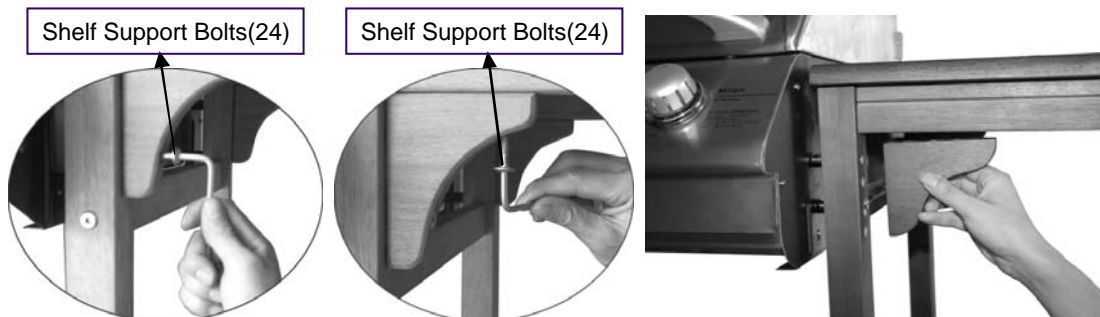



## Ignition Assembly



[17] Shield, x1



[16] Electronic Ignition, x1



[18] Electronic Ignition Battery, x1



[29] ST4.0 x 15 Screw, x2

### 9

Install the Electronic Ignition(16)and Shield(17) to the left front leg with two ST4.0x15 Screws(29).

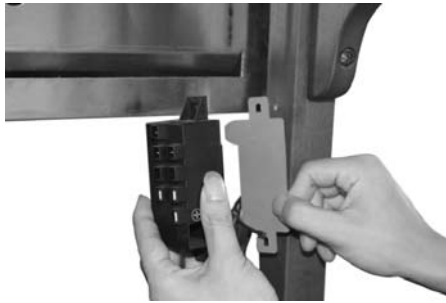

### 10

Connect the wire A and B to the Ignition Assembly as shown. Install the Electronic Ignition Battery(18) in the battery compartment, ensure the battery is placed as marked (+)(-).

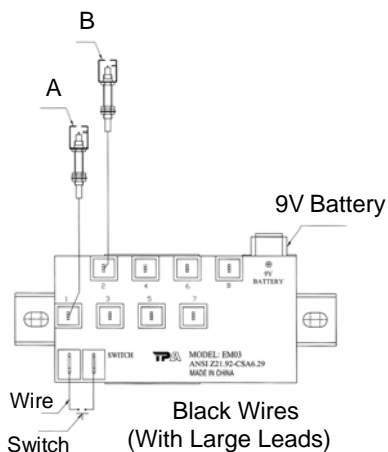

## Grill Assembly



[9] Drip Tray, x1



[10] Hose/Regulator Assembly, x1

### 11

Slide the Drip Tray(9) underneath the barbecue body.

**NOTE:** - Important – Follow drip tray advice on page 15.



### 12

**IMPORTANT:** Carefully screw the hex hose fitting onto the threaded gas inlet assembly.

**IMPORTANT:** Screw hand tight only. Then using a spanner turn the hex nut a further 1/8 of a turn to ensure tightened. (DO NOT OVERTIGHTEN – DO NOT USE ANY SEALING TAPE OR LIQUID ON THE CONNECTION.)



## ASSEMBLY IS NOW COMPLETE.

**IMPORTANT - PROCEED TO THE NEXT PAGE FOR LEAK TESTING BEFORE USE, FAILURE TO CHECK AND PERFORM THE LEAK TEST COULD CAUSE SERIOUS INJURY, AND DAMAGE THE BARBECUE.**

**IMPORTANT- PLEASE ENSURE THE GAS HOSE IS FREE OF KINKS, TWISTS AND FROM ITS TRANSIT POSITION.**

## Leak Testing

- **IMPORTANT - PERFORM LEAK TEST BEFORE USE.**
- **NEVER USE AN OPEN FLAME** to test for leaks at anytime, **DO NOT IGNITE THE BARBECUE DURING THE LEAK TESTING.**
- To be performed in a well –ventilated area.
- Confirm all the control knobs are in the off position.
- Check for leaks by brushing a solution of ½ water and ½ soap over all gas system joints, including all valve connections, hose connections and regulator connections.
- Ensure soap solution has been applied to all connections – connect the regulator to the gas cylinder, open the gas control valve on the regulator allowing the gas to flow.
- **OBSERVE** – if bubbles form over any part of the joints there is a leak.
- Turn off the gas and tighten all joints.
- Repeat test. If bubbles form again, do not use the barbecue. Please contact your local dealer for assistance.
- Leak test annually and whenever the gas bottle is removed or replaced.

## Gas and Regulator

- This barbecue can use either propane or butane LPG bottled gas.
- Propane bottles, (patio gas green) will supply gas all year round, even on cold winter days.
- Butane bottles, normally blue, or BBQ gas will supply sufficient gas in summer. Butane gas must not be used in colder temperatures. Contact your local gas supplier for advice.
- The bottle should never be stood on the trolley base and placed directly under the barbecue.
- Gas bottles should never be stored or used laid on their side.
- Never store gas bottles indoors.
- For optimal performance, we suggest the following:

Model	Butane Minimum Bottle Size	Propane Minimum Bottle Size (Patio Gas)
Albany 3 Burner	15kg	13kg

- This barbecue is intended for use with LPG bottled gas only. (A regulator of 28mbar must be used for Butane gas or 37mbar for Propane gas.)
- This appliance has been supplied with a PROPANE REGULATOR (only use with Propane gas).
- **NEVER** use an adjustable regulator with this barbecue, not suitable for (red) commercial propane cylinders.

- Please contact your local gas supplier for advice on suitable gas bottles and regulators.

## Siting Instructions

- This barbecue is for **OUTDOOR USE ONLY** and should be placed in a well-ventilated area.
- Take care to ensure that it is not placed **UNDER** any combustible surface.
- The sides of the barbecue should **NEVER** be closer than 1 metre from any combustible surface.
- Keep this barbecue away from any flammable materials!
- Important - Do not obstruct any ventilation openings in the barbecue body.
- Position the gas supply bottle on level ground next to the barbecue and safely away from any source of heat. Should you need to change the gas bottle, confirm that the barbecue is switched off, and that there are no sources of ignition (cigarettes, open flame, sparks, etc.) near before proceeding.
- Inspect the gas hose to ensure it is free of any twisting or tension. The hose should hang freely with no bends, folds, or kinks that could obstruct free flow of gas. Apart from the connection point, no part of the hose should touch any hot barbecue parts.
- Always inspect the hose for cuts, cracks, or excessive wear before use.
- If the hose is damaged, it must be replaced with hose suitable for use with LPG and meet the national standards for the country of use. The length of the hose shall not exceed 1.5m.
- N.B.-The date on U.K. orange hose is the date of manufacture, not the expiry date.

## Connecting to the Cylinder

- Confirm all barbecue control knobs are in the off position.
- Connect the regulator to the gas bottle according to your regulator and bottle dealer's instructions.

## Use Instructions

Before proceeding, make certain that you understand the **WARNINGS** section of this manual.

- Preparation before cooking - To prevent foods from sticking to the cooking grill, please use a long handled brush to apply a light coat of cooking or vegetable oil before each barbecuing session.
- Note: When cooking for the first time, paint colours may change slightly as a result. This is normal and should be expected.

### Lighting the Barbecue

- Open the barbecue hood.
- Ensure all knobs are in the off position. Open the gas control valve on the gas bottle or regulator.
- Push and turn the leftmost control knob to the high position. Press the ignition button rapidly several times until left portion of the burner is lit.
- If burner fails to ignite, turn control knob to the off position and turn gas off at the bottle or regulator. Wait five minutes, then repeat the above steps.
- If the burner fails to ignite after following above procedure, turn all the knobs to the off position. Close the gas valve on the gas bottle. Wait 5 minutes, then repeat the above steps. If the barbecue still fails to light, please refer to the manual ignition instructions in section below.
- After successful lighting, light each burner from left to right as desired.
- After ignition, the burners should be burned at the high position for 3-5 minutes in order to preheat the barbecue. This process should be done before every cooking session. **IMPORTANT** - The hood should be open during preheating.
- After completion of preheating, turn burners to the low position for best cooking results.

### Manual Lighting Instructions

- Insert lit match through the match-lighting hole on the right side of the barbecue.
- Push and turn the right most control knob anti-clockwise to the high position.
- After successful lighting, light each burner from left to right as desired.
- If burner fails to ignite after repeated attempts, contact the helpline number stated in this manual.

### Grill Cooking

The Vapour bar evenly distributes the burner flame across the cooking grill area. The natural food juices produced during cooking fall onto the hot vapour bar below and vaporise. Even cooking of food will be achieved by using the BBQ with the hood down. **This should only be done with the burners on low.**

### Flare-Up Control

**IMPORTANT— FLARE UPS CAN OCCUR FROM RESIDUE FAT AND JUICES DRIPPING ONTO THE BURNERS AND HOT VAPOUR BAR.** To reduce this regularly clean the burners and vapour bar. To control flare-up, it is advisable to trim away excess fat from meat and poultry before grilling. The burners should always be placed on the low setting during cooking. Always protect your hands when handling anything near the cooking surface of the barbecue.

### End of Cooking Session

After each cooking session, turn the barbecue burners to the “high” position and burn for 5 minutes. This procedure will burn off cooking residue, thus making cleaning easier.

### Turning Off Your Barbecue

When you have finished using your barbecue, turn all the control valves fully clockwise to the "Off" position, then switch off the gas at the bottle. Wait until the barbecue is sufficiently cool before replacing the lid or closing the hood.

### Care and Maintenance

- Regularly clean your barbecue between uses and especially after extended periods of storage.
- Ensure the barbecue and its components are sufficiently cool before cleaning.
- Do not leave the barbecue exposed to outside weather conditions or stored in damp, moist areas.
- Never douse the barbecue with water when its surfaces are hot.
- Never handle hot parts with unprotected hands.
- In order to extend the life and maintain the condition of your barbecue, we strongly recommend that the unit be covered when left outside for any length of time, especially during the winter months.
- **IMPORTANT** - We recommend that servicing of this appliance should be performed either after every 100 hours of use or annually, whichever is achieved soonest

### Cooking Grill

- **IMPORTANT**– Do not use metal barbecue tools. Only use wooden or plastic barbecue tools on the cooking surfaces.
- **IMPORTANT**- Clean with hot soapy water.
- **IMPORTANT**- Do not place cooking pans, plates or other similar items directly onto the griddle hot plate.
- To remove any food residue, use a mild cream cleaner on a non-abrasive pad. Some cleaning products may scratch or cause cooking surface coatings to flake and chip, only use a sponge or kitchen cloth when cleaning.
- Rinse well and dry thoroughly.
- We recommend coating surfaces with cooking oil before commencing cooking, this will help making cooking easier and cleaning of the grills after cooking has finished. Always clean cooking grills after use, do not allow food residue to sit on grills for long periods of time.

### Burner Maintenance

- In normal usage, burning off the residue after cooking will keep the burners clean.
- The burners should be removed and cleaned annually, or whenever heavy build-up is found, to ensure that there are no signs of blockage (debris, insects) in either the burner portholes or the venturi tubes.
- Use a pipe cleaner to clear obstructions.
- A wire brush can be used to remove corrosion from the burner surfaces.

- When refitting the burners, be careful to check that the venturi tubes of the burners fit over the valve outlets.

### **Drip Tray**

- Line the drip tray with aluminium cooking foil.
- Spread a layer of normal sand 10-15mm in depth evenly across the tray.
- This will help absorb fat and also reduce flare-ups during cooking.
- **IMPORTANT**—Always check, clean, and replace the sand in the tray regularly before use. Do not allow the fat residue to build up in the tray.
- **NEVER**— Use without sand in the drip tray.

### **Vapour Bar**

- Clean the vapour bar with soap and warm water using a low abrasive cleaning cloth or sponge!

### **Barbecue Body**

- Regularly remove excess grease or fat from the barbecue body with a soft plastic or wooden scraper.
- It is not necessary to remove all the grease from the body. If you need to clean fully, use hot soapy water and a cloth, or nylon-bristled brush only.
- Remove cooking surfaces and burners before full cleaning.
- Do not immerse the gas controls or manifold in water.
- Check burner operation after carefully refitting into body.

### **Fixings**

- All screws and bolts, etc. should be checked and tightened on a regular basis.

### **Storage**

- Store your barbecue in a cool dry place.
- Cover the burners with aluminium foil in order to prevent insects or other debris from collecting in burner holes.
- If the barbecue is to be stored indoors, the gas bottle must be disconnected and left outside. The gas bottle should always be stored outside, in a dry, well-ventilated area, away from any sources of heat or ignition.
- Do not let children tamper with the bottle.

## Warnings

- This product is for **OUTDOOR USE ONLY**.
- **NEVER** use indoor, in an enclosed area or below ground level.
- This barbecue is intended for use with LPG bottled gas only. (A regulator of 28mbar must be used for Butane gas or 37mbar for Propane gas.)
- This appliance has been supplied with a **PROPANE REGULATOR** (only use with Propane gas).
- **NEVER** use an adjustable regulator with this barbecue.
- Failure to read and follow these instructions could result in serious injury or damage to property.
- This product will become hot when in use—take care when touching.
- Keep children and pets at a safe distance from the unit when in use.
- **DO NOT** move this product when in use.
- Always turn off the gas supply at the gas cylinder when not in use.
- Any modification of this barbecue may be dangerous.
- **DO NOT** leave this product unattended when in use.
- **DO NOT** position the gas cylinder on the lower shelf or direct beneath the barbecue—always keep the cylinder vertical.
- When igniting, always have the hood open.
- **ONLY** use barbecue on a flat **LEVEL** non flammable surface or ground.
- **IMPORTANT**: Ensure the barbecue is positioned on flat level ground to aid with fat/grease run off.
- When positioning, ensure the unit is a minimum of 1 metre from flammable items or structure.
- **DO NOT** cook with the hood down when the control knobs set to 'HIGH' - this will damage your barbecue.
- This barbecue is not intended for use with charcoal or other similar fuel.
- **IMPORTANT – LEAK TEST THE BARBECUE WHEN FULLY ASSEMBLED BEFORE FIRST USE. IN ADDITION** always leak test the unit – annually, when dismantled, when parts are replaced, or if the gas cylinder is removed or replaced. **FAILURE TO DO THIS COULD CAUSE SERIOUS INJURY, OR DAMAGE TO THE BARBECUE.**
- **DO NOT** use petrol, white spirit, lighter fluid, alcohol or other similar chemicals to ignite a barbecue.
- When storing the barbecue or gas cylinder, ensure they are away from flammable materials or liquids.
- The gas cylinder must not be stored next to this or any other appliance.
- Always follow care and maintenance instructions - regularly maintain your barbecue.
- **DO NOT** allow grease, fat or food residue to build on or in barbecue - **RISK OF FIRE**.
- Always replace worn parts- do not use barbecue if a leak, wear, or damage is found.
- Never overload the grill with food - evenly space over the cooking grill surface, ensuring sufficient air circulation to the burners.
- **DO NOT** store or cover the barbecue until fully cooled.
- This product is not suitable for Lava Rock.
- **DO NOT** leave your barbecue uncovered when not in use. Store your appliance in a shed or garage when not in use to protect against the effects of extreme weather conditions, particularly if you live near coastal areas. Prolonged exposure to sunlight, standing water, sea-air/salt water can all cause damage to your barbecue. (A barbecue cover may not be sufficient to protect your appliance in some of these situations).

## Caution

- Regularly clean your barbecue after every use.
- If you smell gas—turn off the barbecue, extinguish all flames, open the barbecue hood. If the odour continues, immediately contact your gas supplier.
- In the event of an uncontrollable fire, immediately disconnect the gas cylinder moving it away from fire and contact the fire services. **DO NOT PUT YOURSELF AT RISK!**
- The use of oven gloves or mittens is recommended when handling hot surfaces.
- Ensure aerosols are not used near this unit when in use.



## Food Cooking Information

Please read and follow this advice when cooking on your barbecue.

- **ALWAYS** wash your hands before or after handling uncooked meat and before eating.
- **ALWAYS** keep raw meat away from cooked meat and other foods.
- Before cooking ensure barbecue grill surfaces and tools are clean and free of old food residues.
- **DO NOT** use the same utensils to handle cooked and uncooked foods.
- Ensure all meat is cooked thoroughly before eating.
- **CAUTION** - eating raw or under cooked meat can cause food poisoning (e.g. bacteria strains such as E.coli).
- To reduce the risk of under cooked meat cut open to ensure it is cooked all the way through internally.
- **CAUTION** - if meat has been cooked sufficiently the meat juices should be clear in colour and there should be no traces of pink/red juice or meat colouring.
- Pre-cooking of larger meat or joints is recommended before finally cooking on your barbecue.
- After cooking on your barbecue always clean the grill cooking surfaces and utensils.

## Technical Data

	CE Approval	Heat Input	Burners	Injector Size	Gas /Pressure
Albany 3 Burner	0359 359BP446	11.8kW	3	1.02mm	Butane/28mbar Propane/37mbar
Gas Consumption: 860g/hr					
Countries of Use: 3+ (28-30/37) BE, FR, IE, IT, LU, PT, ES, GB 3B/P(30) DK, FI, NL, NO, SE					

Specifications are subject to change without prior notice.

This barbecue is specifically manufactured for B&Q Plc by:  
TPA Metals and Machinery (Shenzhen) Co. Ltd.  
Shenzhen, Guangdong Province, China

## Fault Finding

Problem	Possible Cause	Solution
<b>Burner will not light using the ignition system</b>	LP gas cylinder is empty	Replace with full cylinder
	Faulty regulator	Have regulator checked or replace
	Obstructions in burner	Clean burner
	Obstructions in gas jets or gas hose	Clean jets and gas hose
	Electrode wire is loose or disconnected	Reconnect wire
	Electrode or wire is damaged	Change electrode and wire
	Faulty pushbutton ignitor	Change ignitor
<b>Burner will not light with a match</b>	LP gas cylinder is empty	Replace with full cylinder
	Faulty regulator	Have regulator checked or replace
	Obstructions in burner	Clean burner
	Obstructions in gas jets or gas hose	Clean jets and gas hose
<b>Low flame or flashback (fire in burner tube— a hissing or roaring noise may be heard)</b>	LP gas cylinder too small	Use larger cylinder.
	Obstructions in burner	Clean burner
	Obstructions in gas jets or gas hose	Clean jets and gas hose
	Windy conditions.	Use BBQ in a more sheltered position
<b>Gas valve knob difficult to turn</b>	Gas valve jammed	Replace gas valve

**If you have any queries or require advice or spare parts for this product, please call the B&Q Customer Helpline Number 0870 2427164.**

B&Q plc, Chandlers Ford, Hampshire, SO53 3YX.  
Visit us at [www.diy.com](http://www.diy.com) Version 2008