

B&Q































Assembly & Use Instructions Michigan 4 Burner Gas BBQ

These instructions are for your safety. Please read through them thoroughly before use and retain them for future reference.







Parts Supplied

- Please note quantities of parts may vary according to model purchased.
- Please note the letter (P) in the description column denotes a preassembled part.

Ref	Description	Illustration	Qty	Ref	Description	Illustration	Qty
1	Hood - P		1	17	Upper Body Support		1
2	Warming Rack		1	18	Drip Tray Bracket (Left)		1
3	Grill		1	19	Drip Tray Bracket (Right)		1
4	Griddle		1	20	Cabinet Panel, Back		1
5	Vapour Bar		2	21	Cabinet Panel, Bottom		1
6	Burner - P		4	22	Cylinder Support		1
7	Barbecue Body - P		1	23	Door		2
8	Drip Tray		1	24	Basket		1
9	Side Burner Valve /Hose/Regulator Assembly		1	25	Electronic Ignition Assembly		1
10	Side Burner Shelf		1	26	Shield		1
11	Side Shelf		1	27	Grid		1
12	Left Rear Leg		1	28	Caster		2
13	Left Front Leg		1	29	Lockable Caster		2
14	Right Rear Leg		1	30	Side Burner Knob		1
15	Right Front Leg		1	31	Side Burner Knob Bezel		1
16	Side Cabinet Panel		2				

Fixings Supplied

Ref	Description	Illustration	Qty	Ref	Description	Illustration	Qty
32	Trolley Bolt, M6x40		16	35	Trolley Bolt, M6x15		16
33	ST4.0x10 Screw		27	36	Hex Nut, M6		12
34	Panel Bolt, M4x10		4				

Tools Required (not supplied)

- Cross Head Screwdriver
- Adjustable Spanner

Parts Required (not supplied)

- 1x9V Battery

Before You Start

- Check the box and make sure you have all the parts and fittings listed. If not, contact your local B&Q store or the Helpline 0870 2427164 who will be able to help you.
- When you are ready to start, make sure that you have the right tools at hand, plenty of space and a clean dry area for assembly.

Assembly

- Please lay out all nuts and bolts and check lengths before assembling. It is recommended that the carton is cut open and spread out on the floor and used as a protective surface during assembly. Refer to the assembly diagrams as necessary.
- Important - Whilst every care is taken in the manufacture of this product, care must be taken during assembly in case sharp edges are present.
- Remove all transit packaged parts from the inside of the grill body before assembling.
- **IMPORTANT** - Also remove all protective film from stainless steel parts when assembling and before using the barbecue.

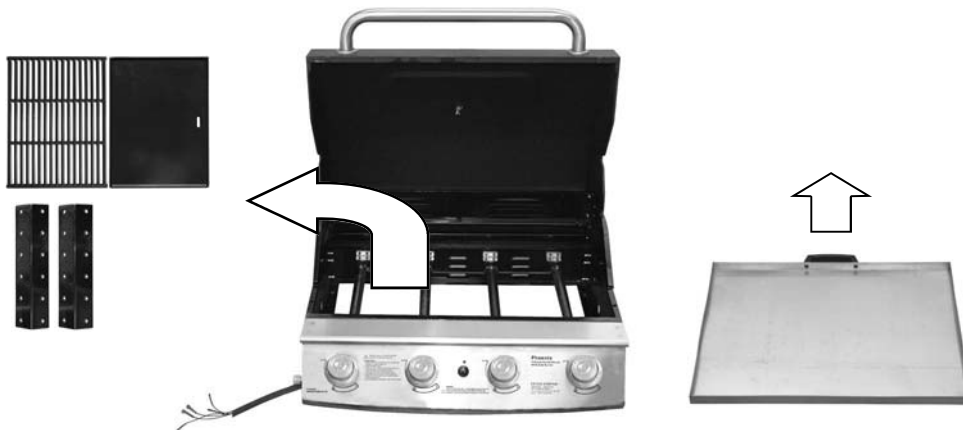

- **IMPORTANT - FOLLOW GAS LEAK TEST ADVICE BEFORE USE. ENSURE ALL CONNECTIONS ARE TIGHT AND SECURE.**
- This product is for **OUTDOOR USE ONLY**.
- **NEVER** use indoor, in an enclosed area or below ground level.
- This barbecue is intended for use with LPG bottled gas only. (A regulator of 28mbar must be used for Butane gas or 37mbar for Propane gas.)
- This appliance has been supplied with a **PROPANE REGULATOR** (only use with Propane gas).
- **NEVER** use an adjustable regulator with this barbecue.

Trolley Assembly

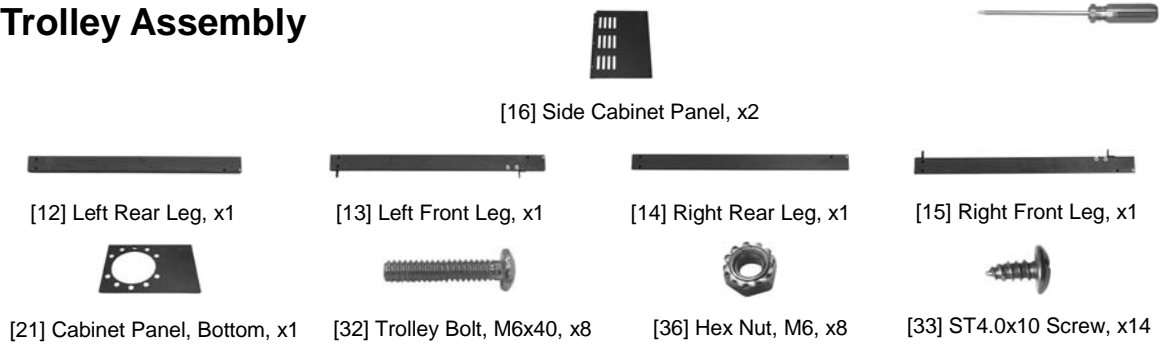

1

Attach the Left/Right Legs (12,13,14,15) to the Side Cabinet Panels (16) using the ST4.0x10 Screw (33) as shown.

Left Cabinet Panel Assembly

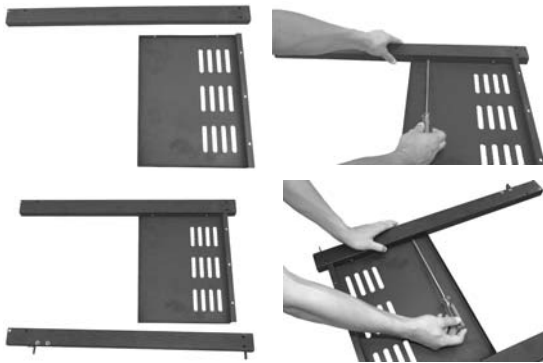

Right Cabinet Panel Assembly

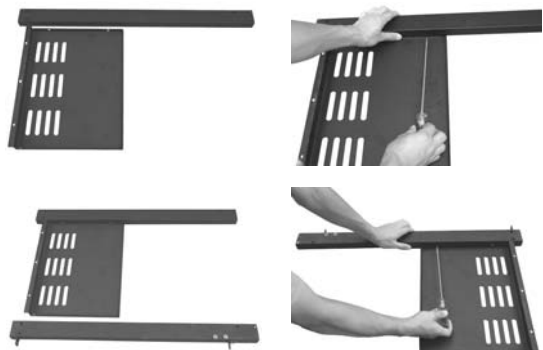

2

Attach the left and right cabinet panels assembly to the Bottom Cabinet Panel (21) using the Trolley Bolt (32) with Hex Nut (36) and ST4.0x10 Screw (33) as shown.

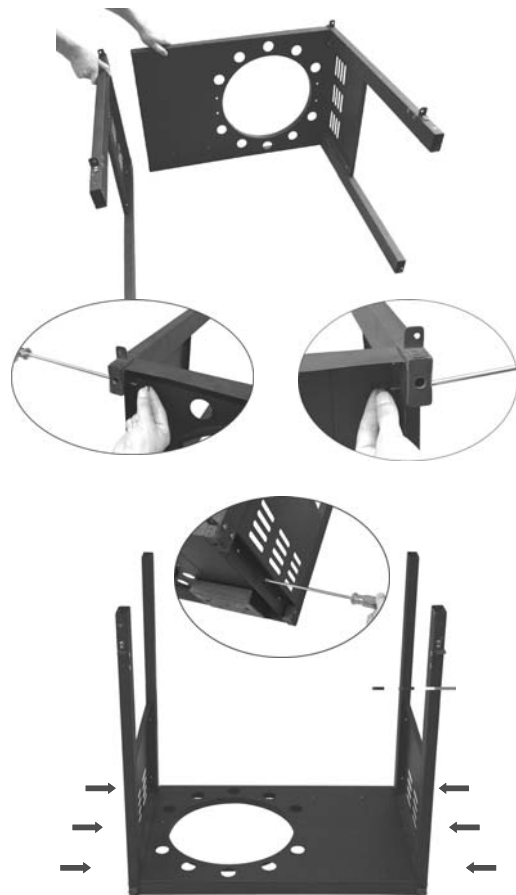

Trolley Assembly



[20] Cabinet Panel, Back x1



[17] Upper Body Support, x1



[22] Cylinder Support, x1



[33] ST4.0x10 Screw, x7



[36] Nut M6, x4



[35] Trolley Bolt M6x15, x8

3

Attach the Cabinet Panel Back (20) to the L/H, R/H panel and bottom panel using the ST4.0x10 Screw (33).

NOTE: These screw holes have weld nuts. No nuts are required for these screws.



4

a. Attach the Upper Body Support (17) to the front legs using Trolley Bolts (35) as shown.



b. Attach the Cylinder Support (22) to the bottom cabinet panel using the Trolley Bolts (35) and Hex Nuts (36).

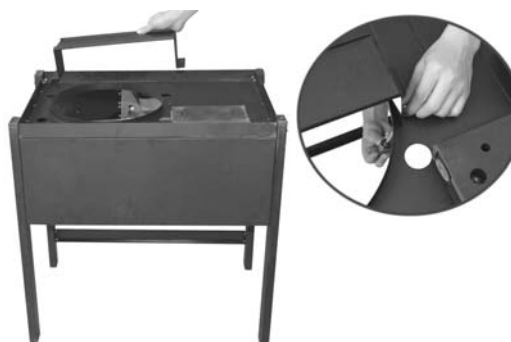

Trolley/Body Assembly



[28] Caster, x2



[29] Lockable Caster, x2



[32] Trolley Bolt, M6x40, x8



5

Install Casters (28) and Lockable Caster (29) by threading them into position as shown.



NOTE: The casters with locking arms attach to the right of the assembly.

6

Assemble the body onto the cabinet structure using Trolley Bolts (32) as shown. (Two persons required)

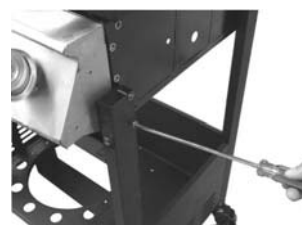

Trolley Assembly



[9] Side Burner Valve/Hose/Regulator Assembly, x1



[10] Side Burner Shelf, x1



[11] Side Shelf, x1



[35] Trolley Bolt, M6x15, x8

7

Connect the Side Burner Valve/Hose/Regulator Assembly (9) to the BBQ body.

IMPORTANT: Warm the end of the hose in hot water for 2 minutes. Ensure the jubilee clip is on the hose, and then push the hose all the way onto the barb. Using a screwdriver turn the retaining screw to tighten the jubilee clip. (DO NOT OVERTIGHTEN – DO NOT USE ANY SEALING TAPE OR LIQUID ON THE CONNECTION.)



IMPORTANT- LEAK TESTING BEFORE USE, FAILURE TO CHECK AND PERFORM THE LEAK TEST COULD CAUSE SERIOUS INJURY, AND DAMAGE THE BARBECUE.

8

Attach the Side Burner Shelf (10)/Side Shelf (11) to the barbecue body using Trolley Bolts (35) as shown. Make sure the side burner is on the left.



Trolley Assembly



[18] Drip Tray Bracket (Left), X1 [19] Drip Tray Bracket (Right), X1 [25] Electronic Ignition Assembly, x1 [26] Shield, x1



[30] Side Burner Knob, x1 [31] Side Burner Knob Bezel, x1 [33] ST4.0x10 Screw, x6 [34] Panel Bolt, M4x10, x4

9

Tighten the Panel Bolts (34) through the side shelf/ side burner shelf onto body side panel as shown.

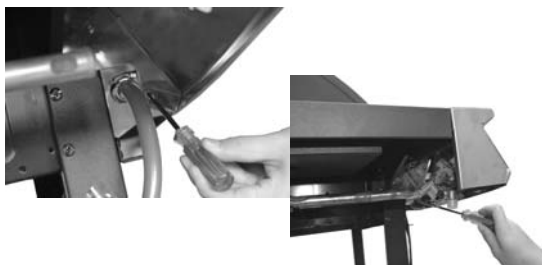

11

Attach the Drip Tray Brackets (18,19) onto the legs using the ST4.0x10 Bolts (33).

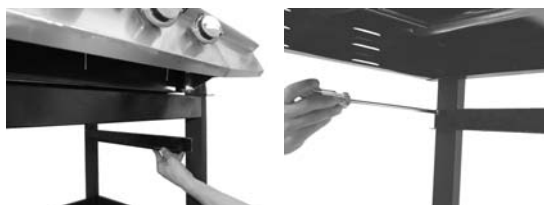

10

Unscrew retaining screws from side burner valve, then insert the retaining screws through the Side Burner Knob Bezel (31), side burner shelf, and screw into side burner valve. Make sure that the venturi end fit over gas outlet nozzle of side burner valve. Press the Side Burner Knob (30) onto side burner valve stem as shown.



12

Install the Electronic Ignition Assembly (25) and Shield (26) to the left front leg with two ST4.0x10 Screws (33).



Door/Drip Tray Assembly



[23] Door, x2



[24] Basket, x1



[8] Drip Tray, x1

13

Connect the wires to the electronic ignition assembly as the diagram below. Install the Electronic Ignition Battery (not supplied) in the battery compartment, ensure the battery is placed as marked (+)(-).



Electronic Ignition Assembly Diagram

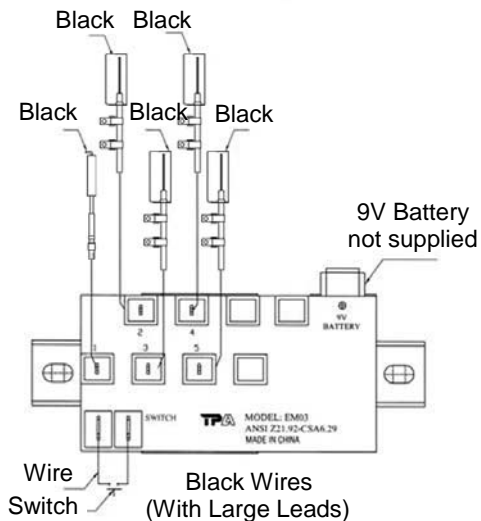

14

Attach the Doors (23) onto the barbecue as shown. Attach the Basket (24) onto the right door as shown.



15

Push Drip Tray (8) into the barbecue along its brackets.

NOTE: - Important – The drip tray must be lined with foil and sand before use. Ensure the sand is replaced regularly. (See page 16) Never remove the drip tray during cooking!



Grill Assembly



[3] Grill, x1



[4] Griddle, x1



[5] Vapour Bar, x2



[2] Warming Rack, x1



[27] Grid, x1

16

Lay Vapour Bars (5), Cooking Grill (3) and Griddle (4) as shown.

Note: The cooking grill must be located over the vapour bars directly.

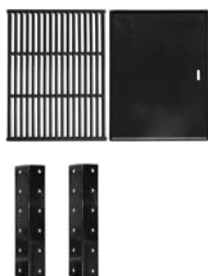

17

Open L/H side burner lid and place the Grid (27) onto the burner. Install the Warming Rack (2) onto barbecue body.

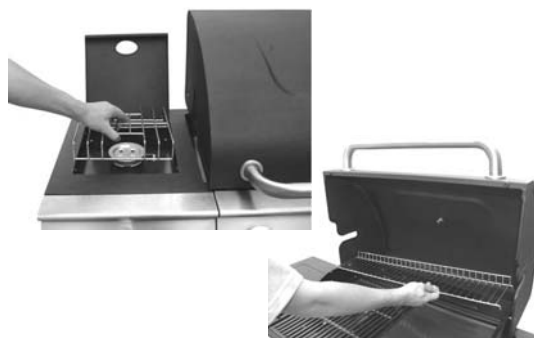

IMPORTANT - PROCEED TO THE NEXT PAGE FOR LEAK TESTING BEFORE USE, FAILURE TO CHECK AND PERFORM THE LEAK TEST COULD CAUSE SERIOUS INJURY, AND DAMAGE THE BARBECUE. IMPORTANT - CHECK THAT JUBILEE CLIPS HAVE BEEN TIGHTENED.



Important- Please ensure the gas hose is free of kinks, twists and from its transit position.

Leak Testing

- **IMPORTANT - PERFORM LEAK TEST BEFORE USE.**
- **NEVER USE AN OPEN FLAME to test for leaks at anytime, DO NOT IGNITE THE BARBECUE DURING THE LEAK TESTING.**
- **To be performed in a well –ventilated area.**
- **Confirm all the control knobs are in the off position.**
- Check for leaks by brushing a solution of ½ water and ½ soap (washing up liquid) over all gas system joints, including all valve connections, hose connections, regulator connections and jubilee clip.
- Ensure soap solution has been applied to all connections – connect the regulator to the gas cylinder, open the gas control valve on the regulator allowing the gas to flow. (**NB - THE CONTROL KNOB MUST BE IN OFF POSITION**)
- Always wipe the mixed solution from all connections after leak testing.
- **OBSERVE** – if bubbles form over any part of the joints there is a leak.
- Turn off the gas and tighten all joints.
- Repeat test. If bubbles form again, do not use the barbecue. Please contact your local dealer for assistance.
- Leak test annually and whenever the gas bottle is removed or replaced.

Gas and Regulator

- This barbecue can use either propane or butane LPG bottled gas.
- Propane bottles, (patio gas green) will supply gas all year round, even on cold winter days.
- Butane bottles, normally blue, or BBQ gas will supply sufficient gas in summer. Butane gas must not be used in colder temperatures. Contact your local gas supplier for advice.
- Gas bottles should never be stored or used laid on their side.
- Never store gas bottles indoors.
- For optimal performance, we suggest the following:

Model	Butane Minimum Bottle Size	Propane Minimum Bottle Size (Patio Gas)
Michigan 4 Burner	15kg	13kg

- This barbecue is intended for use with LPG bottled gas only. (A regulator of 28mbar must be used for Butane gas or 37mbar for Propane gas.)
- This appliance has been supplied with a PROPANE REGULATOR (only use with Propane gas).

- NEVER use an adjustable regulator with this barbecue, not suitable for (red) commercial propane cylinders.
- Please contact your local gas supplier for advice on suitable gas bottles and regulators.

Siting Instructions

- This barbecue is for **OUTDOOR USE ONLY** and should be placed in a well-ventilated area.
- Take care to ensure that it is not placed UNDER any combustible surface.
- The sides of the barbecue should NEVER be closer than 1 metre from any combustible surface.
- Keep this barbecue away from any flammable materials!
- Important - Do not obstruct any ventilation openings in the barbecue body.
- Position the gas supply bottle on level ground next to the barbecue and safely away from any source of heat. Should you need to change the gas bottle, confirm that the barbecue is switched off, and that there are no sources of ignition (cigarettes, open flame, sparks, etc.) near before proceeding.
- Inspect the gas hose to ensure it is free of any twisting or tension. The hose should hang freely with no bends, folds, or kinks that could obstruct free flow of gas. Apart from the connection point, no part of the hose should touch any hot barbecue parts.
- Always inspect the hose for cuts, cracks, or excessive wear before use.
- If the hose is damaged, it must be replaced with hose suitable for use with LPG and meet the national standards for the country of use. The length of the hose shall not exceed 1.5m.
- N.B.-The date on U.K. orange hose is the date of manufacture, not the expiry date.

Connecting to the Cylinder

- Confirm all barbecue control knobs are in the off position.
- Connect the regulator to the gas bottle according to your regulator and bottle dealer's instructions.

Use Instructions

Before proceeding, make certain that you understand the WARNINGS

section of this manual.

- Preparation before cooking - To prevent foods from sticking to the cooking grill, please use a long handled brush to apply a light coat of cooking or vegetable oil before each barbecuing session.
- Note: When cooking for the first time, paint colours may change slightly as a result. This is normal and should be expected.

Lighting the Barbecue

- Open the barbecue hood.
- Ensure all knobs are in the off position. Open the gas control valve on the gas bottle or regulator.
- Push and turn the leftmost control knob to the high position. Press the ignition button rapidly several times until left portion of the burner is lit.
- If burner fails to ignite, turn control knob to the off position and turn gas off at the bottle or regulator. Wait five minutes, then repeat the above steps.
- If the burner fails to ignite after following above procedure, turn all the knobs to the off position. Close the gas valve on the gas bottle. Wait 5 minutes, then repeat the above steps. If the barbecue still fails to light, please refer to the manual ignition instructions in section below.
- After successful lighting, light each burner from left to right as desired.
- After ignition, the burners should be burned at the high position for 3-5 minutes in order to preheat the barbecue. This process should be done before every cooking session. **IMPORTANT** - The hood should be open during preheating.
- After completion of preheating, turn burners to the low position for best cooking results.

Manual Lighting Instructions

- Insert lit match through the match-lighting hole on the right side of the barbecue.
- Push and turn the right most control knob anti-clockwise to the high position.
- After successful lighting, light each burner from left to right as desired.
- If burner fails to ignite after repeated attempts, contact the helpline number stated in this manual.

Grill Cooking

The Vapour bar evenly distributes the burner flame across the cooking grill area. The natural food juices produced during cooking fall onto the hot vapour bar below and vaporise. Even cooking of food will be achieved by using the BBQ with the hood down. **This should only be done with the burners on low.**

Flare-Up Control

IMPORTANT— FLARE UPS CAN OCCUR FROM RESIDUE FAT AND JUICES DRIPPING ONTO THE BURNERS AND HOT VAPOUR BAR. To reduce this regularly clean the burners and vapour bar. To control flare-up, it is advisable to trim away excess fat from meat and poultry before grilling. The burners should always be placed on the low setting during cooking. Always protect your hands when handling anything near the cooking surface of the barbecue.

End of Cooking Session

After each cooking session, turn the barbecue burners to the “high” position and burn for 5 minutes. This procedure will burn off cooking residue, thus making cleaning easier.

Turning Off Your Barbecue

When you have finished using your barbecue, turn all the control valves fully clockwise to the “Off” position, then switch off the gas at the bottle. Wait until the barbecue is sufficiently cool before closing the hood.

Care and Maintenance

- Regularly clean your barbecue between uses and especially after extended periods of storage.
- Ensure the barbecue and its components are sufficiently cool before cleaning.
- Do not leave the barbecue exposed to outside weather conditions or stored in damp, moist areas.
- Never douse the barbecue with water when its surfaces are hot.
- Never handle hot parts with unprotected hands.
- In order to extend the life and maintain the condition of your barbecue, we strongly recommend that the unit be covered when left outside for any length of time, especially during the winter months.
- **IMPORTANT** - We recommend that servicing of this appliance should be performed either after every 100 hours of use or annually, whichever is achieved soonest.

Cooking Grill

- **IMPORTANT**– Metal cooking barbecue tool can be used on the cooking surfaces. It is recommended if the cooking tool has pointed or serrated parts/edges that care is taken in use, so not to scratch or damage the grill or griddle cooking surface.

- **IMPORTANT**– Do not use metal grill brushes or abrasive pads on the grill or griddle cooking surfaces. This will scratch and damage the cooking surface.
- **IMPORTANT**– Clean with hot water.
- To remove any food residue, use a mild cream cleaner on a non-abrasive pad. Some cleaning products may scratch or cause cooking surface coatings to flake and chip, only use a sponge or kitchen cloth when cleaning.
- Rinse well and dry thoroughly.
- We recommend coating surfaces with cooking oil before commencing cooking, this will help making cooking easier and cleaning of the grills after cooking has finished. Always clean cooking grills after use, do not allow food residue to sit on grills for long periods of time.

Burner Maintenance

- In normal usage, burning off the residue after cooking will keep the burners clean.
- The burners should be removed and cleaned annually, or whenever heavy build-up is found, to ensure that there are no signs of blockage (debris, insects) in either the burner portholes or the venturi tubes.
- Use a pipe cleaner to clear obstructions.
- A wire brush can be used to remove corrosion from the burner surfaces.
- When refitting the burners, be careful to check that the venturi tubes of the burners fit over the valve outlets.

Drip Tray

- Spread a layer of normal sand 10-15mm in depth evenly across the tray.
- This will help absorb fat and also reduce flare-ups during cooking.
- **IMPORTANT**—Always check, clean, and replace the sand in the tray regularly before use. Do not allow the fat residue to build up in the tray.
- **NEVER**— Use without sand in the drip tray.

Vapour Bar

- Clean the vapour bar with soap and warm water using a low abrasive cleaning cloth or sponge!

Barbecue Body

- Regularly remove excess grease or fat from the barbecue body with a soft plastic or wooden scraper.
- It is not necessary to remove all the grease from the body. If you need to clean fully, use hot soapy water and a cloth, or nylon-bristled brush only.

- Remove cooking surfaces and burners before full cleaning.
- Do not immerse the gas controls or manifold in water.
- Check burner operation after carefully refitting into body.

Fixings

- All screws and bolts, etc. should be checked and tightened on a regular basis.

Storage

- Store your barbecue in a cool dry place.
- Cover the burners with aluminium foil in order to prevent insects or other debris from collecting in burner holes.
- If the barbecue is to be stored indoors, the gas bottle must be disconnected and left outside. The gas bottle should always be stored outside, in a dry, well-ventilated area, away from any sources of heat or ignition.
- Do not let children tamper with the bottle.

Warnings

- This product is for **OUTDOOR USE ONLY**.
- **NEVER** use indoor, in an enclosed area or below ground level.
- This barbecue is intended for use with LPG bottled gas only. (A regulator of 28mbar must be used for Butane gas or 37mbar for Propane gas.)
- This appliance has been supplied with a **PROPANE REGULATOR** (only use with Propane gas).
- **NEVER** use an adjustable regulator with this barbecue.
- Failure to read and follow these instructions could result in serious injury or damage to property.
- This product will become hot when in use—take care when touching.
- Keep children and pets at a safe distance from the unit when in use.
- **DO NOT** move this product when in use.
- Always turn off the gas supply at the gas cylinder when not in use.
- Any modification of this barbecue may be dangerous.
- **DO NOT** leave this product unattended when in use.
- When igniting, always have the hood open.
- **ONLY** use barbecue on a flat **LEVEL** non flammable surface or ground.
- **IMPORTANT** – ensure the barbecue is positioned on flat level ground to aid with fat/grease run off.
- When positioning, ensure the unit is a minimum of 1 metre from flammable items or structure.
- **DO NOT** cook with the hood down when the control knobs set to 'HIGH' - this will damage your barbecue. (With hood down cook on 'Low')
- This barbecue is not intended for use with charcoal or other similar fuel.
- **IMPORTANT – LEAK TEST THE BARBECUE WHEN FULLY ASSEMBLED BEFORE FIRST USE. IN ADDITION** always leak test the unit – annually, when dismantled, when parts are replaced, or if the gas cylinder is removed or replaced. **FAILURE TO DO THIS COULD CAUSE SERIOUS INJURY, OR DAMAGE TO THE BARBECUE.**
- **DO NOT** use petrol, white spirit, lighter fluid, alcohol or other similar chemicals to ignite a barbecue.
- When storing the barbecue or gas cylinder, ensure they are away from flammable materials or liquids.
- The gas cylinder must not be stored next to this or any other appliance.
- Always follow care and maintenance instructions - regularly maintain your barbecue.
- **DO NOT** allow grease, fat or food residue to build on or in barbecue - **RISK OF FIRE.**
- Always replace worn parts- do not use barbecue if a leak, wear, or damage is found.
- Never overload the grill with food - evenly space over the cooking grill surface, ensuring sufficient air circulation to the burners.
- **DO NOT** store or cover the barbecue until fully cooled.
- This product is not suitable for use with Lava Rock.
- **DO NOT** leave your barbecue uncovered when not in use. Store your appliance in a shed or garage when not in use to protect against the effects of extreme weather conditions, particularly if you live near coastal areas. Prolonged exposure to sunlight, standing water, sea-air/salt water can all cause damage to your barbecue. (A barbecue cover may not be sufficient to protect your appliance in some of these situations).

Caution

- Regularly clean your barbecue after every use.
- If you smell gas—turn off the barbecue, extinguish all flames, open the barbecue hood. If the odour continues, immediately contact your gas supplier.
- In the event of an uncontrollable fire, immediately disconnect the gas cylinder moving it away from fire and contact the fire services. **DO NOT PUT YOURSELF AT RISK!**
- The use of oven gloves or mittens is recommended when handling hot surfaces.
- Ensure aerosols are not used near this unit when in use.
- Ensure all packaging and plastic bags are disposed of safely.
- **IMPORTANT**– Do not use abrasive cleaners or materials when cleaning enamel cooking grills or surfaces.

Food Cooking Information

Please read and follow this advice when cooking on your barbecue.

- **ALWAYS** wash your hands before or after handling uncooked meat and before eating.
- **ALWAYS** keep raw meat away from cooked meat and other foods.
- Before cooking ensure barbecue grill surfaces and tools are clean and free of old food residues.
- **DO NOT** use the same utensils to handle cooked and uncooked foods.
- Ensure all meat is cooked thoroughly before eating.
- **CAUTION** - eating raw or under cooked meat can cause food poisoning (e.g. bacteria strains such as E.coli).
- To reduce the risk of under cooked meat cut open to ensure it is cooked all the way through internally.
- **CAUTION** - if meat has been cooked sufficiently the meat juices should be clear in colour and there should be no traces of pink/red juice or meat colouring.
- Pre-cooking of larger meat or joints is recommended before finally cooking on your barbecue.
- After cooking on your barbecue always clean the grill cooking surfaces and utensils.

Technical Data

	CE Approval	Heat Input	Burners	Injector Size	Gas /Pressure
Michigan 4 Burner	0359 359BP446	11.8kW	4	0.89mm	Butane/28mbar Propane/37mbar
Side Burner	0359 359BP446	2.8kW	1	0.84mm	
Gas Consumption:1090g/hr					
Countries of Use: I ₃₊ (28-30/37) BE, FR, IE, IT, LU, PT, ES, GB I _{3B/P(30)} DK, FI, NL, NO, SE					

Specifications are subject to change without prior notice.

This barbecue is specifically manufactured for B&Q Plc by:
TPA Metals and Machinery (Shenzhen) Co. Ltd.
Shenzhen, Guangdong Province, China

Fault Finding

Problem	Possible Cause	Solution
Burner will not light using the ignition system	LP gas cylinder is empty	Replace with full cylinder
	Faulty regulator	Have regulator checked or replace
	Obstructions in burner	Clean burner
	Obstructions in gas jets or gas hose	Clean jets and gas hose
	Electrode wire is loose or disconnected on electrode or ignition unit	Reconnect wire
	Electrode or wire is damaged	Change electrode and wire
	Faulty pushbutton ignitor	Change ignitor
Burner will not light with a match	LP gas cylinder is empty	Replace with full cylinder
	Faulty regulator	Have regulator checked or replace
	Obstructions in burner	Clean burner
	Obstructions in gas jets or gas hose	Clean jets and gas hose
Low flame or flashback (fire in burner tube— a hissing or roaring noise may be heard)	LP gas cylinder too small	Use larger cylinder.
	Obstructions in burner	Clean burner
	Obstructions in gas jets or gas hose	Clean jets and gas hose
	Windy conditions	Use BBQ in a more sheltered position
Gas valve knob difficult to turn	Gas valve jammed	Replace gas valve

If you have any queries or require advice or spare parts for this product, please call the B&Q Customer Helpline Number 0870 2427164.